

PRODUCT DATA SHEET

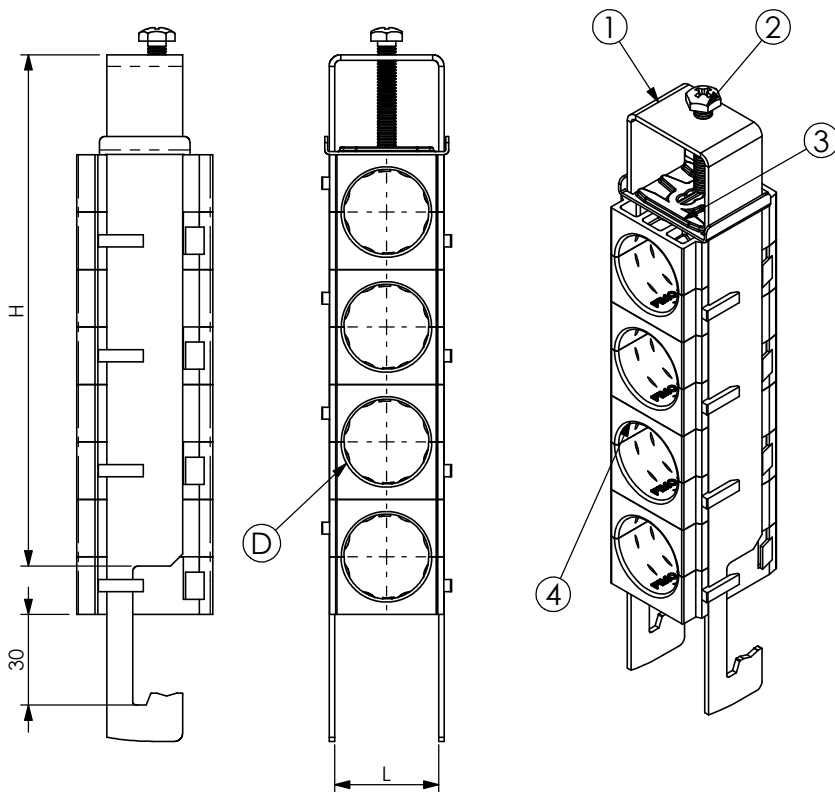

A) SPECIFICATIONS

- 1 Stainless steel bow
Hooking on on L shaped
angular support 30x30mm
- 2 Self-locking pressure screw M6
- 3 Stainless steel sliding pressure plate.
- 4 SAS black P.A. fiberglass saddles

B) RESISTANCE TESTS

UV Test BS-ISO 105-B06
Vibration test conforming to UNI 60068-2-6
Operating temperature: -30°C +120°C

C) PACKAGING INFORMATION

Packing in boxes.
Label indicating:
product code, article, quantity,
production batch,
FIMO logo and figure.
(Customer code on request).

D) MOUNTING INSTRUCTIONS

IST026

CODE	ARTICLE	ø D	L	H	BOX	WEIGHT
61 1552 1411	sRF A3/ 4x11	10 - 11	22	118	50	173
61 1552 1412	sRF A3/ 4x1/2" (17)	16 - 17	22	118	50	166
61 1552 1478	sRF A3/ 4x7/8" (28)	27 - 28	34	166	50	293

RI	DATE	DR	DATE	AP	Description:
02					Stainless cable clamps type sRF A3 For 4 coaxial cables, complete with 8 calibrated saddles. For articles see schedule.
01					
00	05/10/15	G.S.	05/10/15	A.V.	
1 ST EMISSION					
Use:					Fastening of 4 coaxial cables to angular 30 x 30 mm.